



## ORBIT MIRROR JULIET – INSTALLATION GUIDE

UNLESS OTHERWISE STATED ALL DIMENSIONS IN MILLIMETRES AND APPLY TO STANDARD HEIGHT SYSTEMS.  
DO NOT SCALE FROM ANY DRAWINGS.

BALCONETTE, UNIT 6 SYSTEMS HOUSE, EASTBOURNE ROAD, BLINDLEY HEATH, SURREY, RH7 6JP  
TEL: 01342 410 411 FAX: 01342 410 412 WWW.BALCONETTE.CO.UK

### Before you start:

- Check you have all the parts of the order.
- Check the height of the glass panel(s).
- Check the system can span the opening in the structure.
- Read and understand these instructions before starting installation.

### Orbit Juliet System Details

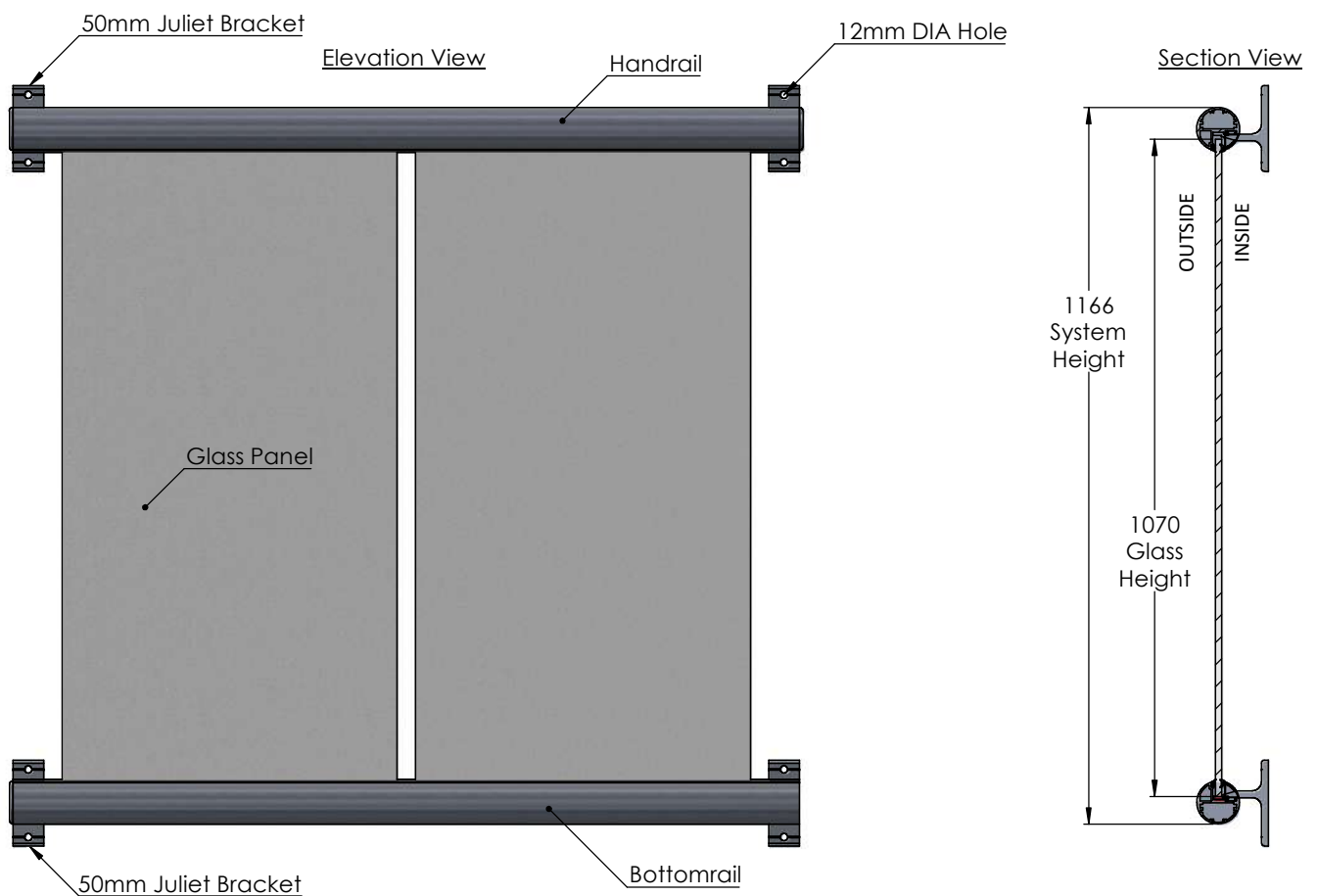

**Not Supplied:** Silicone and fixings to the structure are not included.

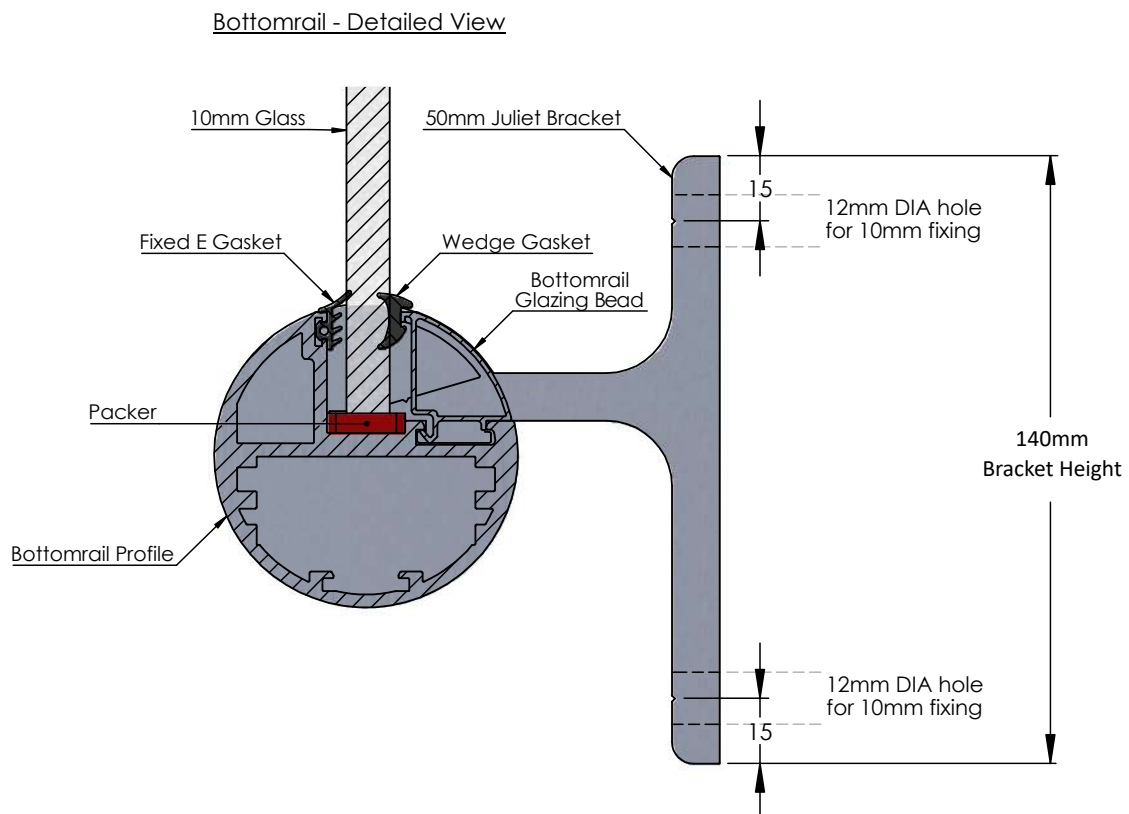
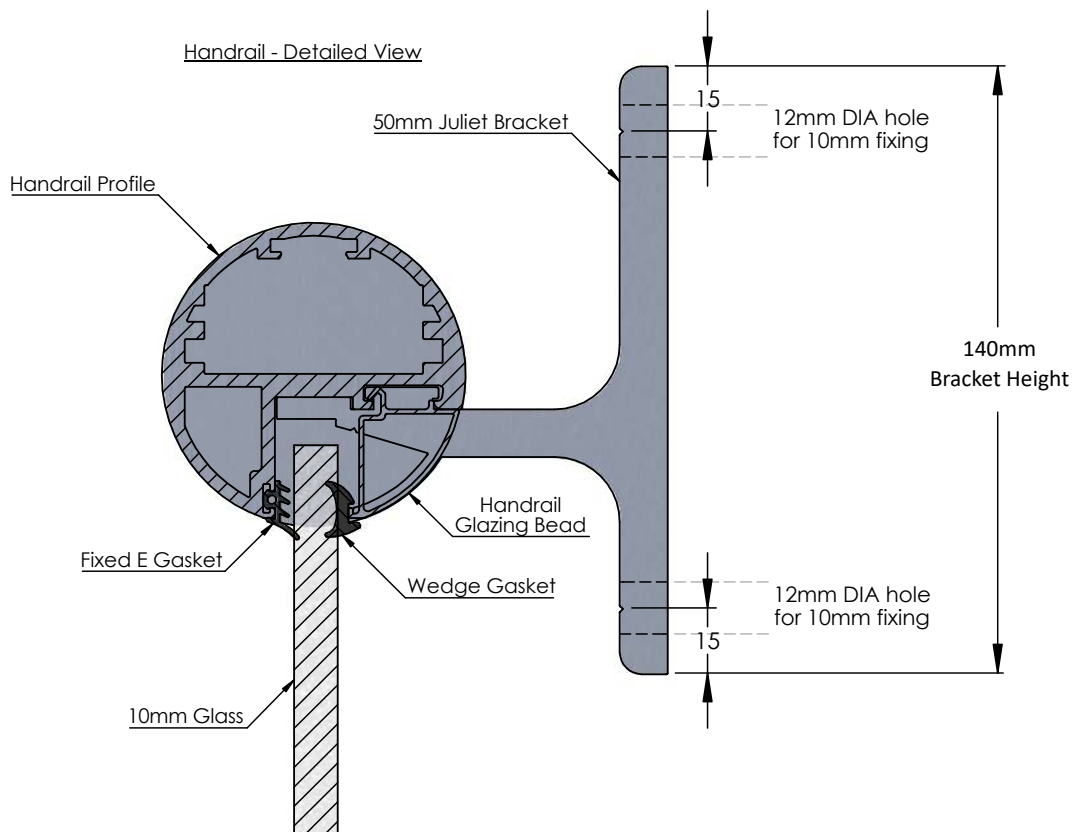

**Not Supplied:** Silicone and fixings to the structure are not included.



01) Unpack your Juliet, remove the handrail and bottomrail glazing beads and place to one side.

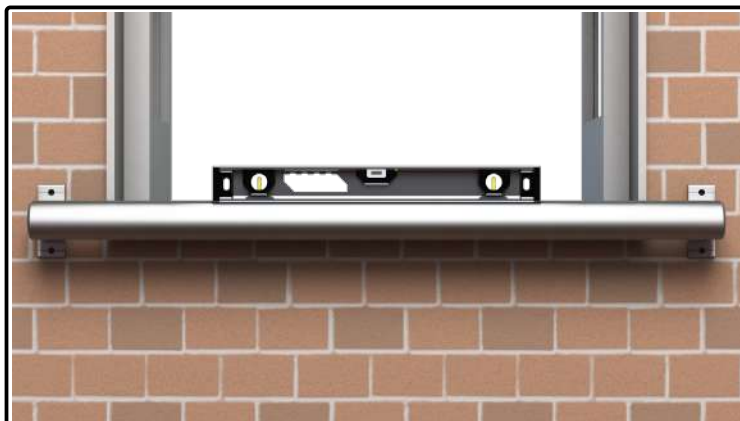

02) Position the bottomrail centrally and level over the opening.



03) Position the bottomrail to give access to install the glazing bead so that a standard system height of 1166mm (underside of the bottomrail to the top of the handrail) achieves a minimum of 1100mm from the top of the handrail to the finished floor level.

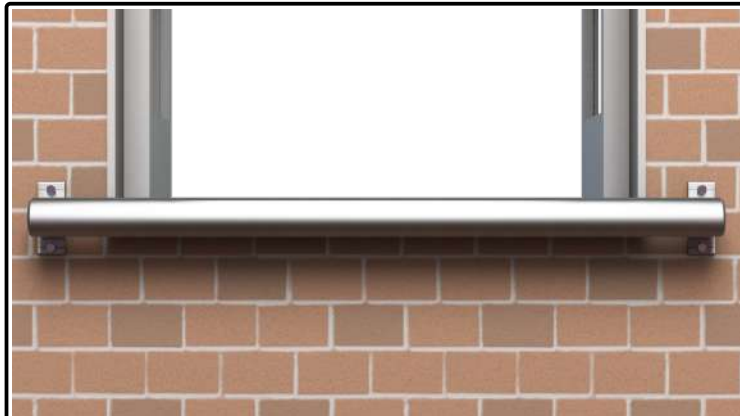

04) Once positioned correctly mark the fixing locations and with suitable fixings fix the bottomrail to the structure.

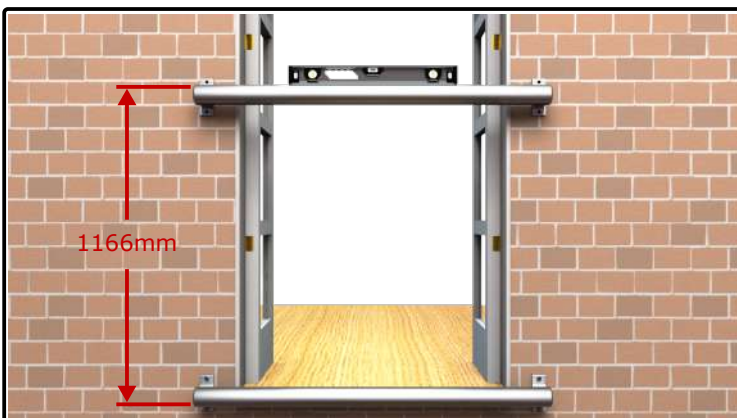

05) Measure the 1166mm from the underside of the bottomrail. Position the handrail centrally and level over the opening.

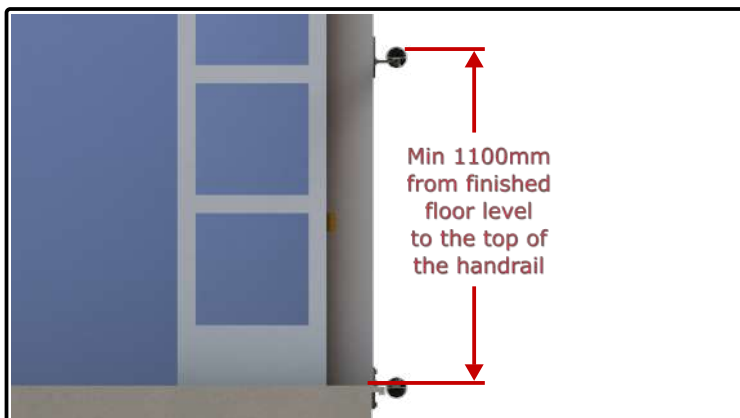

06) Ensure the handrail is at a minimum of 1100mm from the finished floor level.



07) Once positioned correctly mark the fixing locations and with suitable fixings fix the handrail to the structure.



08) Stick two 5mm glass packers per glass panel into the bottomrail with a blob of silicone.



09) Remove any labels, spacers or films from the glass panel(s)

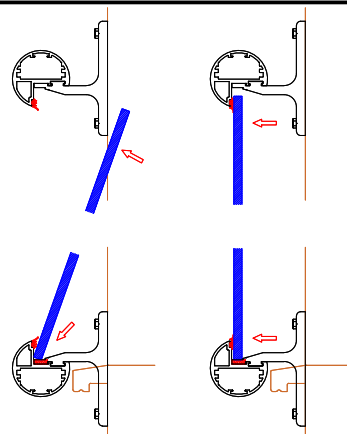

10) Seat a glass panel onto the packers and pivot the panel up to make contact with the fixed (E) gaskets.

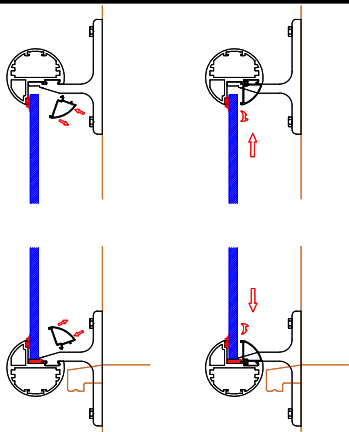

11) Install the bottomrail and handrail glazing bead bits and wedge gasket to hold the glass panel(s) temporarily.

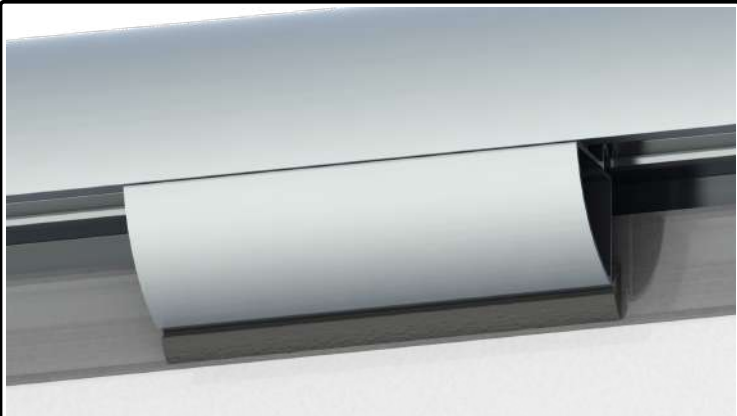

12) Installed handrail glazing bead bits and wedge rubber.

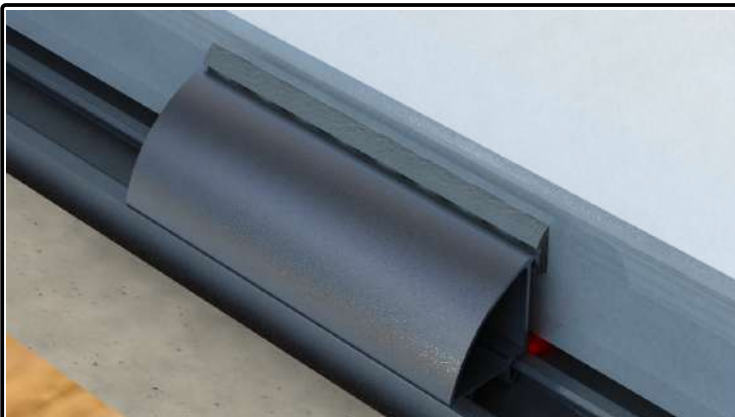

13) Installed bottomrail glazing bead bits and wedge rubber.

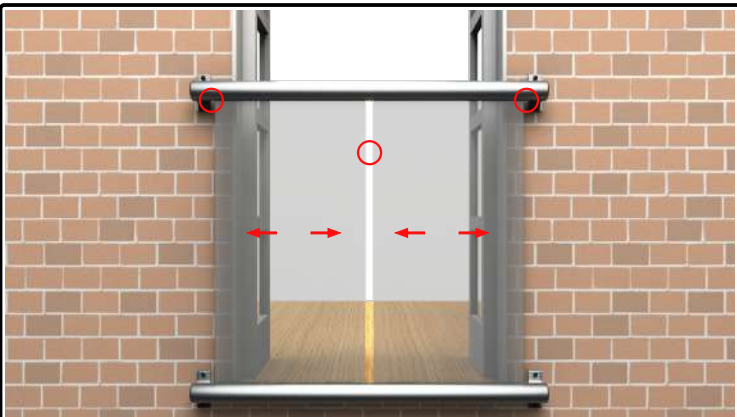

14) Adjust the glass panels and gaps as required.

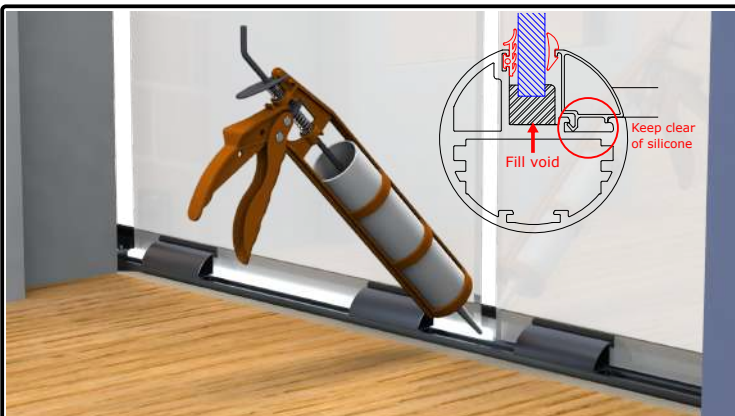

15) Apply a continuous silicone bead to fill the void between the bottomrail and the glass panel(s).

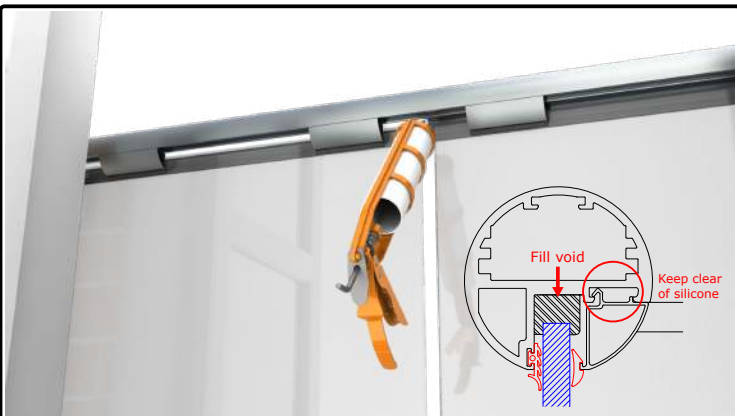

16) Apply a continuous silicone bead to fill the void between the handrail and the glass panel(s).



17) Once the silicone has fully cured replace the bottomrail clip bits with the full length glazing bead and wedge gasket. Trim off any excess gasket.



18) Once the silicone has fully cured replace the handrail clip bits with the full length glazing bead and wedge gasket. Trim off any excess gasket.

